

SPECIFICATIONS

FOR TOPLIGHT COB MODULE

MODEL: ATE-R23



TOPLIGHT INTERNATIONAL LLC.

www.toplightusa.com



TECHNICAL DATA SHEET

ATE-R23 SERIES <FOR TOPLIGHT COB MODULE>

1. PRODUCT APPEARANCE

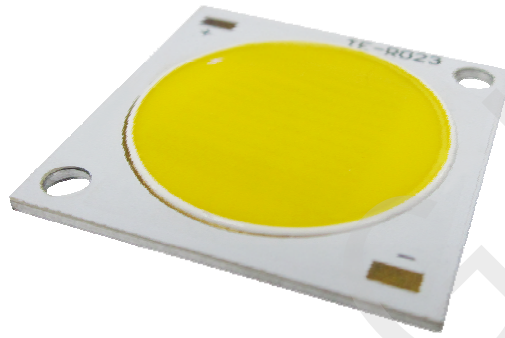

2. OUTLINE DRAWING

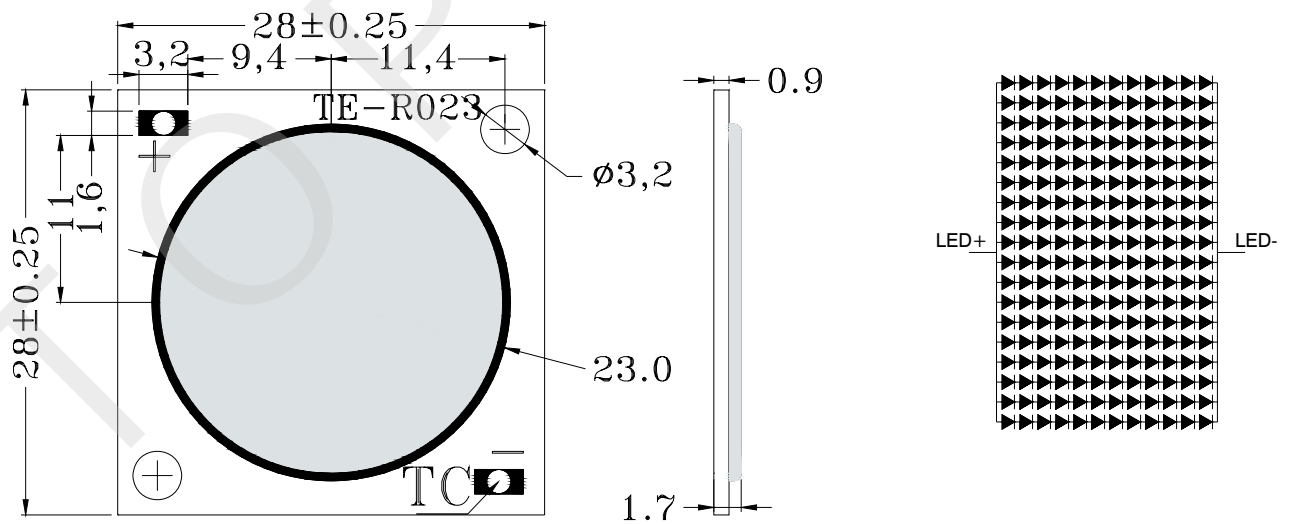

Unit: mm

Tolerance: ±0.25

**TECHNICAL DATA SHEET****ATE-R23 SERIES** <FOR TOPLIGHT COB MODULE>**3. PERFORMANCE PARAMETERS****3-1. ABSOLUTE MAXIMUM RATINGS**

ITEM	SYMBOL	RATING	UNIT
Power Dissipation	P	70.2	W
Forward Current	I _F	1800	mA
Reverse Voltage	V _R	60	V
Operating Temperature	T _{opr}	- 30 ~ + 65	°C
Storage Temperature	T _{stg}	- 40 ~ + 100	°C
Junction Temperature	T _{jmax}	+ 125	°C
Thermal Resistance	RJ-C	3.5	°C/W

Note:

*1. Forward Current allows maximum surge current ≤ 10 ms.

*2. Power dissipation and forward current are the values when the LED is used within the range of the derating curve in this data sheet.



TECHNICAL DATA SHEET

ATE-R23 SERIES <FOR TOPLIGHT COB MODULE>

3-2. ELECTRICAL-OPTICAL CHARACTERISTICS

(T_a=25°C)

**	PARAMETER	SYMBOL	CONDITION	MIN.	TYP.	MAX.	UNIT	
common	Forward Voltage ^{*1}	V _F	I _F =1080mA	34	36	39	V	
	Beam Angle	Deg		—	120	—	Deg	
W	** Color Temp.	T _C	I _F =1080mA	2870	3045	3220	K	
	** Color Rendering Index ^{*3}	R _a		80	—	—	—	
	W ₁	Luminous Flux ^{*2}		Φ	3200	3500	—	lm
		Luminous Efficiency		η	80	90	—	lm/W
	W ₂	Luminous Flux ^{*2}		Φ	3501	3800	—	lm
		Luminous Efficiency		η	91	97	—	lm/W
	W ₃	Luminous Flux ^{*2}		Φ	3801	4200	—	lm
		Luminous Efficiency		η	98	105	—	lm/W
D	** Color Temp.	T _C	I _F =1080mA	4745	5028	5311	K	
	** Color Rendering Index ^{*3}	R _a		80	—	—	—	
	D ₁	Luminous Flux ^{*2}		Φ	3500	3800	—	lm
		Luminous Efficiency		η	91	97	—	lm/W
	D ₂	Luminous Flux ^{*2}		Φ	3801	4100	—	lm
		Luminous Efficiency		η	98	105	—	lm/W
	D ₃	Luminous Flux ^{*2}		Φ	4101	4400	—	lm
		Luminous Efficiency		η	106	110	—	lm/W
C	** Color Temp.	T _C	I _F =1080mA	6020	6530	7040	K	
	** Color Rendering Index ^{*3}	R _a		80	—	—	—	
	C ₁	Luminous Flux ^{*2}		Φ	3600	3900	—	lm
		Luminous Efficiency		η	92	99	—	lm/W
	C ₂	Luminous Flux ^{*2}		Φ	3901	4200	—	lm
		Luminous Efficiency		η	100	108	—	lm/W
	C ₃	Luminous Flux ^{*2}		Φ	4201	4500	—	lm
		Luminous Efficiency		η	109	115	—	lm/W

(Note) Parameters is formulated based on shipping samples

*1. After 20 ms drive, Measurement tolerance: ± 3 %

*2. Monitored by Toplight's 1 m integrating sphere, after 20 ms drive, Measurement tolerance: ± 10 %

*3. Monitored by Toplight's 1 m integrating sphere, after 20 ms drive, Measurement tolerance:± 2



TECHNICAL DATA SHEET

ATE-R23 SERIES <FOR TOPLIGHT COB MODULE>

3-3. Characteristics diagram (TYP.)

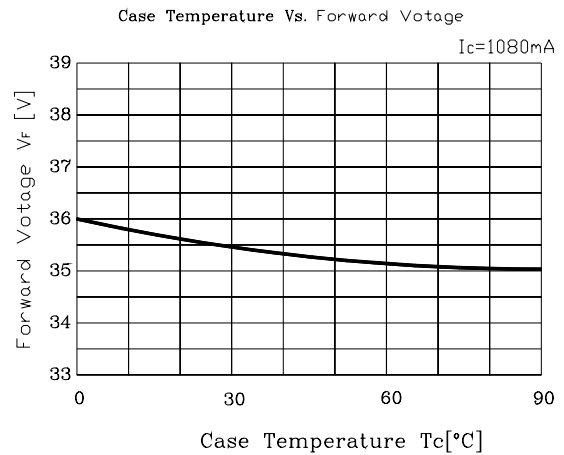
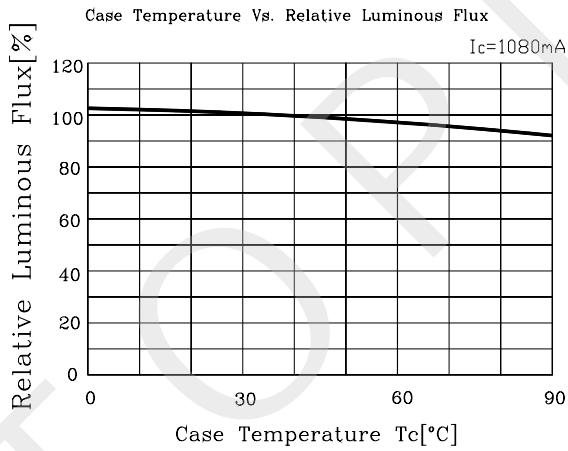
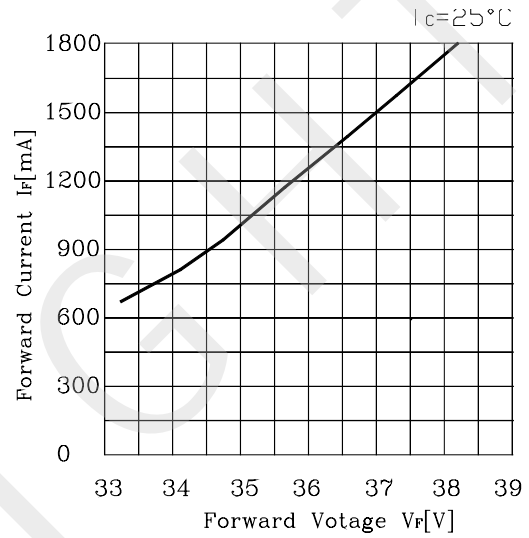
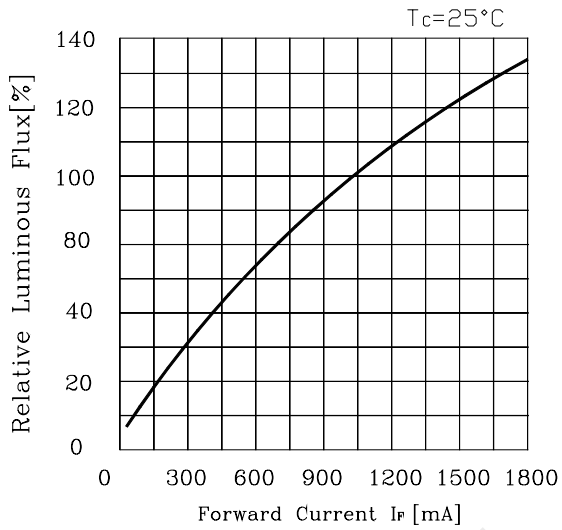

**TECHNICAL DATA SHEET****ATE-R23 SERIES**

<FOR TOPLIGHT COB MODULE>

5 / 8

4. RELIABILITY

The reliability of products shall be satisfied with items listed below.

4-1. TEST ITEMS AND TEST CONDITIONS

NO.	TEST ITEM	TEST CONDITIONS	RESULT
1	Continuous operation test	$T_a = 25^{\circ}\text{C}$, $I_F = 1080\text{mA} \times 1000$ hours(with Al fin)	PASS
		$T_a = 80^{\circ}\text{C}$, $T_j = 120^{\circ}\text{C}$, $I_F = 1080\text{mA} \times 1000$ hours(with Al fin)	
2	Low temperature storage	$T_a = -40^{\circ}\text{C} \times 1000$ hours	PASS
3	High temperature storage	$T_a = 100^{\circ}\text{C} \times 1000$ hours	PASS
4	Moisture resistance	$T_a = 60^{\circ}\text{C}$, 90%RH for 1000 hours	PASS
5	Thermal shock	$T_a = -40^{\circ}\text{C} \times 30$ minutes $\sim 100^{\circ}\text{C} \times 30$ minutes, 100 cycle	PASS

4-2. FAILURE CRITERIA

NO.	PARAMETER	SYMBOL	FAILURE CRITERIA
1	Forward Voltage	V_F	$V_F > \text{Initial value} \times 1.1$
2	Luminous Flux	Φ	$\Phi < \text{Initial value} \times 0.7$



TECHNICAL DATA SHEET

ATE-R23 SERIES <FOR TOPLIGHT COB MODULE>

5. CHROMATICITY COORDINATES REGIONAL

5-1. 3000K CHROMATICITY COORDINATES

(Tolerance: $x,y \pm 0.005$)

($I_F=1080mA, T_c=25^\circ C$)

Range		Chromaticity coordinates				
		NO.1	NO.2	NO.3	NO.4	NO.5
	x	0.4363	0.4305	0.4320	0.4340	0.4377
	y	0.4201	0.4206	0.4201	0.4188	0.4180

* The percentage of each rank in the shipment shall be determined by TOPLIGHT.

Chromaticity Diagram

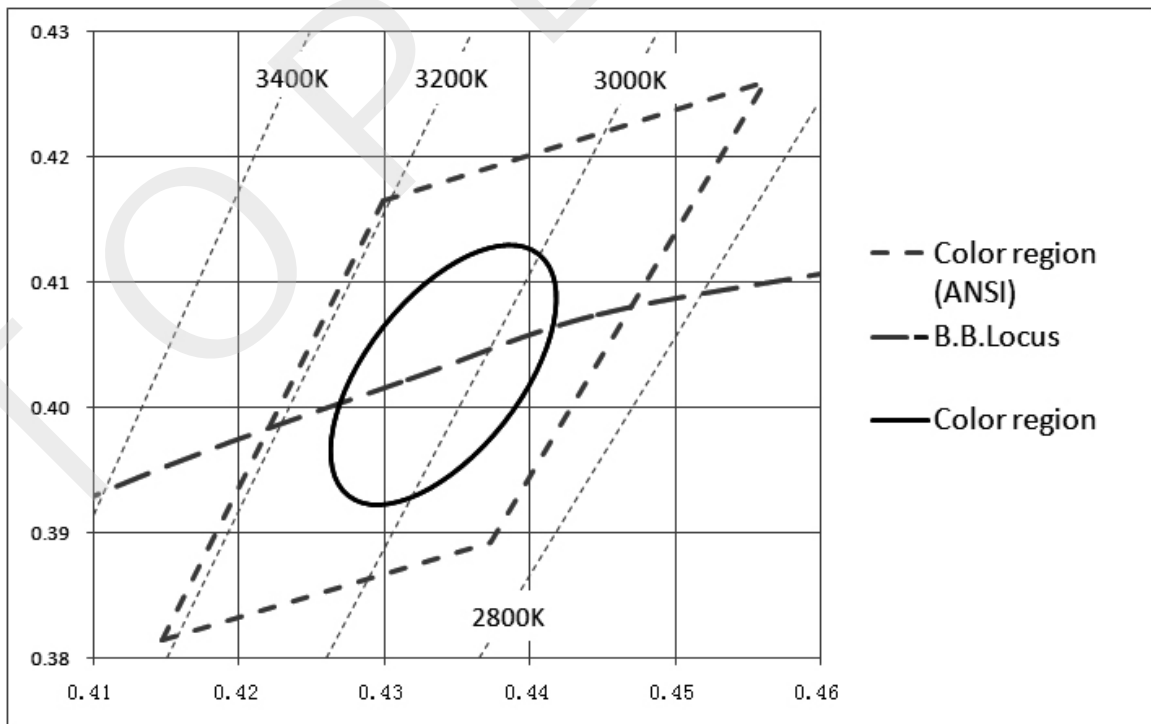

Note: The tolerance of measurement at our tester is $V_F \pm 3\%$, $D_v \pm 10\%$, Chromaticity(x,y) ± 0.005 .



TECHNICAL DATA SHEET

ATE-R23 SERIES <FOR TOPLIGHT COB MODULE>

5-2. 5000K CHROMATICITY COORDINATES

(Tolerance: $x,y \pm 0.005$)

($I_F = 1080\text{mA}$, $T_c = 25^\circ\text{C}$)

Range		Chromaticity coordinates				
		NO.1	NO.2	NO.3	NO.4	NO.5
	x	0.3551	0.3376	0.3366	0.3515	0.3551
	y	0.376	0.3616	0.3369	0.3487	0.376

* The percentage of each rank in the shipment shall be determined by TOPLIGHT.

Chromaticity Diagram

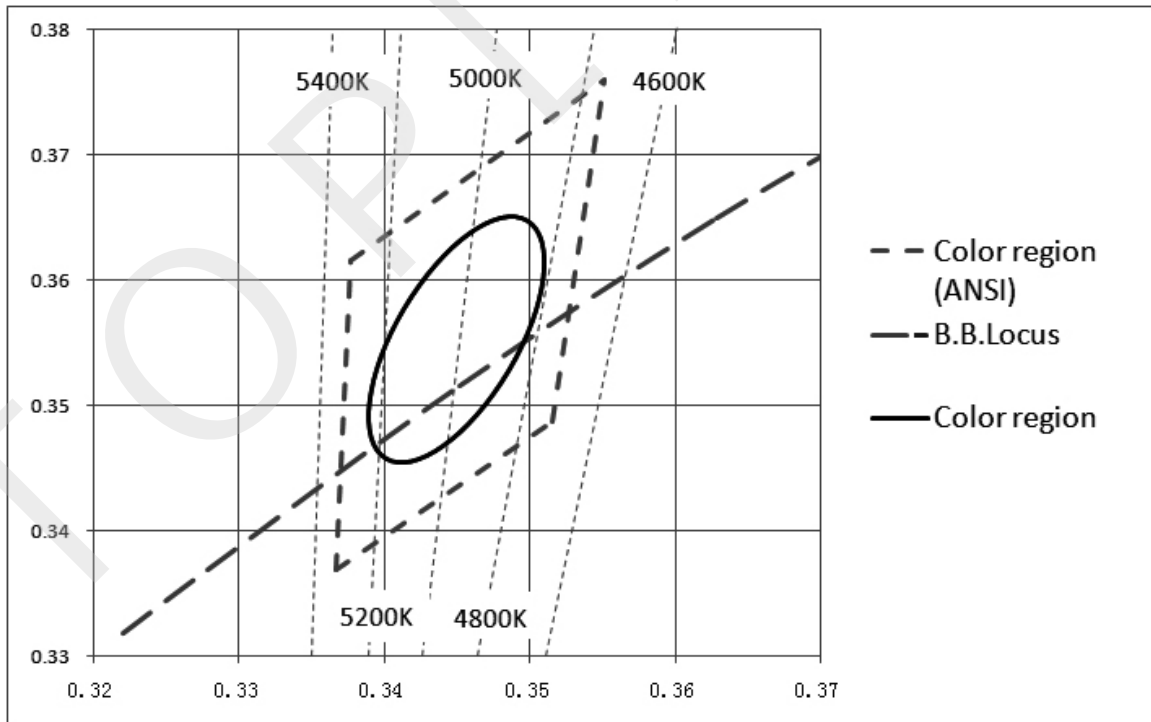

Note: The tolerance of measurement at our tester is $V_F \pm 3\%$, $D_v \pm 10\%$, Chromaticity(x,y) ± 0.005 .



TECHNICAL DATA SHEET

ATE-R23 SERIES <FOR TOPLIGHT COB MODULE>

5-3. 6500K CHROMATICITY COORDINATES

(Tolerance: x,y ± 0.005)

(I_F =1080mA, T_c= 25°C)

Range		Chromaticity coordinates				
		NO.1	NO.2	NO.3	NO.4	NO.5
	x	0.3205	0.3028	0.3068	0.3221	0.3205
	y	0.3481	0.3304	0.3113	0.3261	0.3481

* The percentage of each rank in the shipment shall be determined by TOPLIGHT.

Chromaticity Diagram

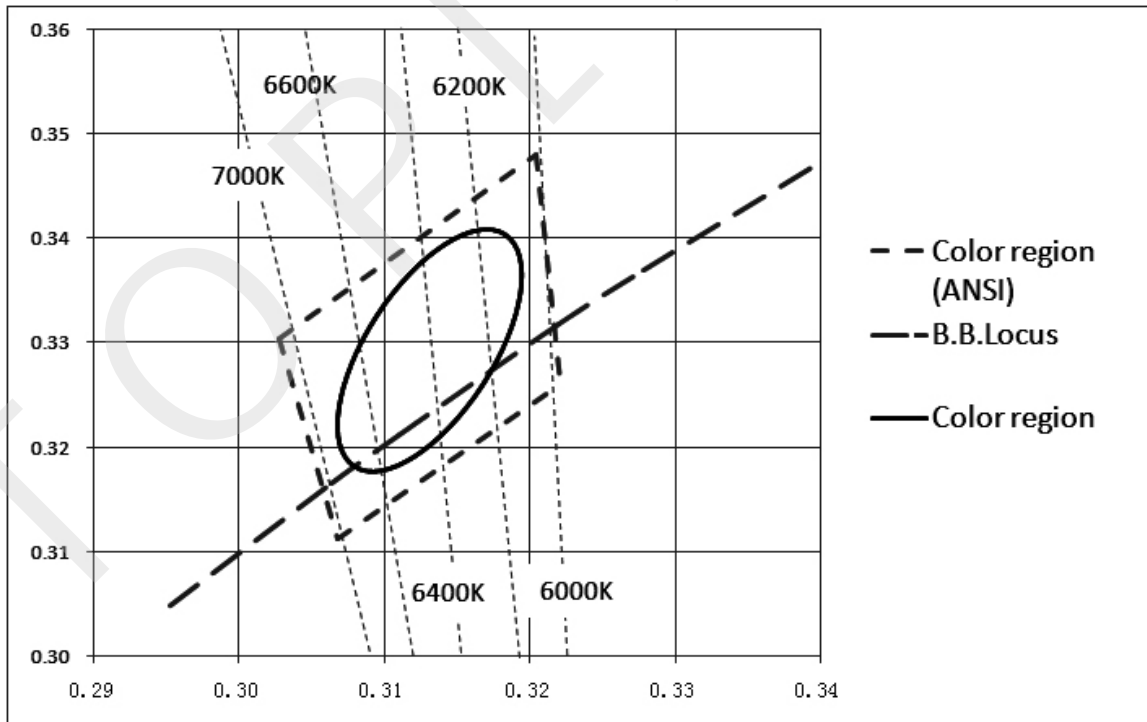

Note: The tolerance of measurement at our tester is VF±3% , Dv±10% , Chromaticity(x,y)±0.005.