

SPECIFICATIONS

FOR TOPLIGHT COB MODULE

MODEL: ATE-R10



TOPLIGHT INTERNATIONAL LLC.

www.toplightusa.com



TECHNICAL DATA SHEET

ATE-R10 SERIES <FOR TOPLIGHT COB MODULE>

1. PRODUCT APPEARANCE

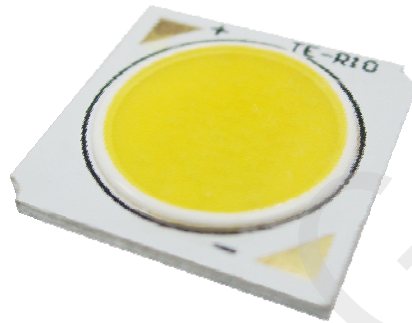

2. OUTLINE DRAWING

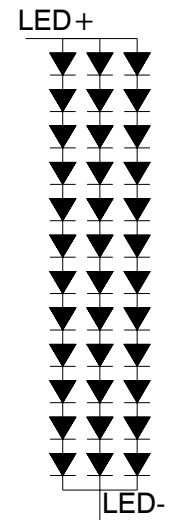
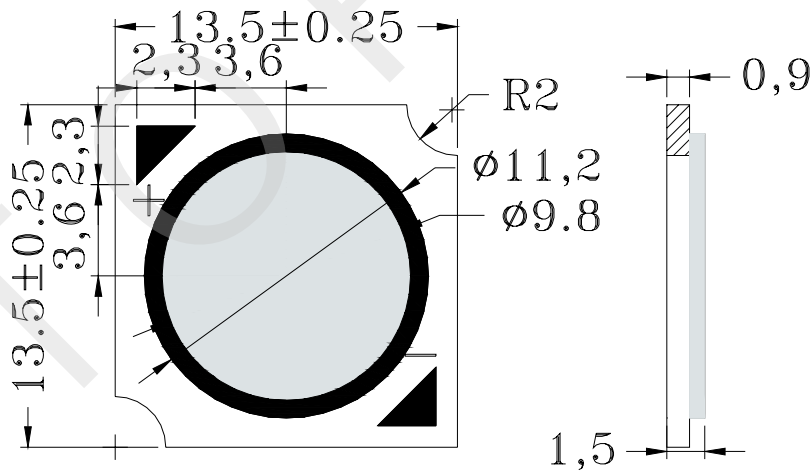

Unit: mm

Tolerance: ±0.25

**TECHNICAL DATA SHEET****ATE-R10 SERIES** <FOR TOPLIGHT COB MODULE>**3. PERFORMANCE PARAMETERS****3-1. ABSOLUTE MAXIMUM RATINGS**

ITEM	SYMBOL	RATING	UNIT
Power Dissipation	P	11.7	W
Forward Current	I _F	300	mA
Reverse Voltage	V _R	60	V
Operating Temperature	T _{opr}	- 30 ~ + 65	°C
Storage Temperature	T _{stg}	- 40 ~ + 100	°C
Junction Temperature	T _{jmax}	+ 125	°C
Thermal Resistance	RJ-C	3.5	°C/W

Note:

*1. Forward Current allows maximum surge current ≤ 10 ms.

*2. Power dissipation and forward current are the values when the LED is used within the range of the derating curve in this data sheet.



TECHNICAL DATA SHEET

ATE-R10 SERIES <FOR TOPLIGHT COB MODULE>

3-2. ELECTRICAL-OPTICAL CHARACTERISTICS

(T_a=25°C)

**	PARAMETER	SYMBOL	CONDITION	MIN.	TYP.	MAX.	UNIT	
common	Forward Voltage ^{*1}	V _F	I _F =180mA	33	36	39	V	
	Beam Angle	Deg		—	120	—	Deg	
W	** Color Temp.	T _C	I _F =180mA	2870	3045	3220	K	
	** Color Rendering Index ^{*3}	R _a		80	—	—	—	
	W ₁	Luminous Flux ^{*2}		Φ	550	600	—	lm
		Luminous Efficiency		η	80	90	—	lm/W
	W ₂	Luminous Flux ^{*2}		Φ	601	650	—	lm
		Luminous Efficiency		η	91	100	—	lm/W
	W ₃	Luminous Flux ^{*2}		Φ	651	700	—	lm
		Luminous Efficiency		η	101	108	—	lm/W
D	** Color Temp.	T _C	I _F =180mA	4745	5028	5311	K	
	** Color Rendering Index ^{*3}	R _a		80	—	—	—	
	D ₁	Luminous Flux ^{*2}		Φ	570	620	—	lm
		Luminous Efficiency		η	85	95	—	lm/W
	D ₂	Luminous Flux ^{*2}		Φ	621	670	—	lm
		Luminous Efficiency		η	96	102	—	lm/W
	D ₃	Luminous Flux ^{*2}		Φ	671	720	—	lm
		Luminous Efficiency		η	103	110	—	lm/W
C	** Color Temp.	T _C	I _F =180mA	6020	6530	7040	K	
	** Color Rendering Index ^{*3}	R _a		80	—	—	—	
	C ₁	Luminous Flux ^{*2}		Φ	580	630	—	lm
		Luminous Efficiency		η	88	96	—	lm/W
	C ₂	Luminous Flux ^{*2}		Φ	631	680	—	lm
		Luminous Efficiency		η	97	104	—	lm/W
	C ₃	Luminous Flux ^{*2}		Φ	681	730	—	lm
		Luminous Efficiency		η	105	112	—	lm/W

(Note) Parameters is formulated based on shipping samples

*1. After 20 ms drive, Measurement tolerance: ± 3 %

*2. Monitored by Toplight's 1 m integrating sphere, after 20 ms drive, Measurement tolerance: ± 10 %

*3. Monitored by Toplight's 1 m integrating sphere, after 20 ms drive, Measurement tolerance:± 2



TECHNICAL DATA SHEET

ATE-R10 SERIES <FOR TOPLIGHT COB MODULE>

3-3. Characteristics diagram (TYP.)

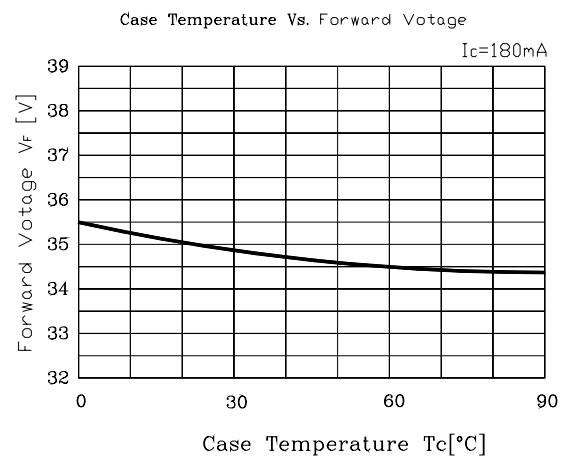
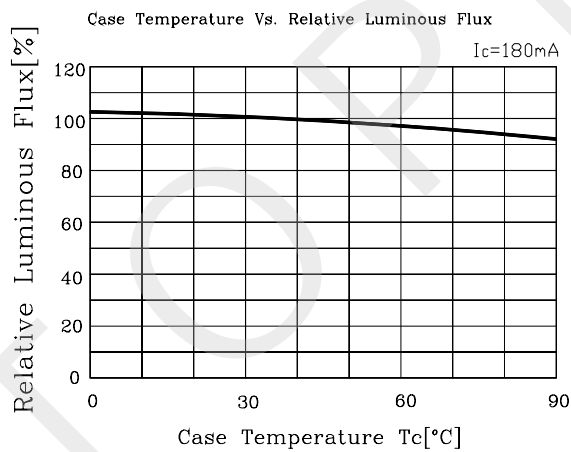
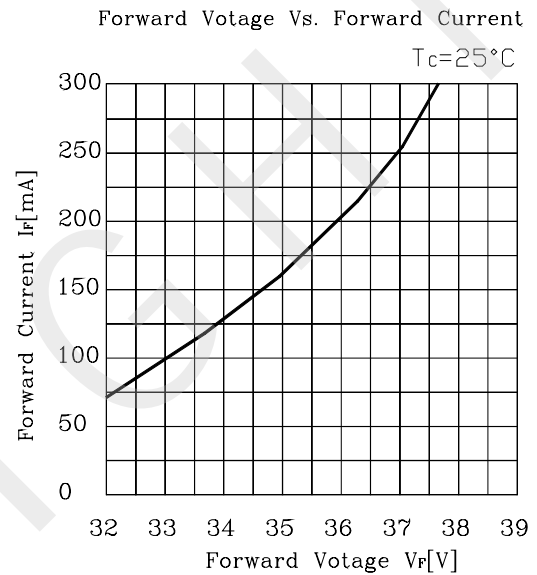
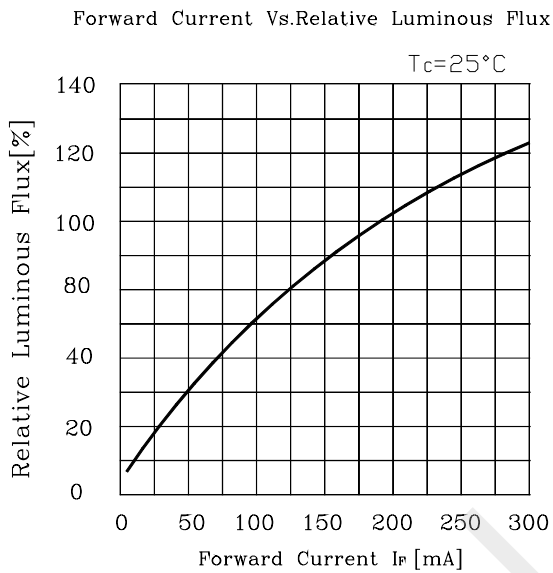

**TECHNICAL DATA SHEET****ATE-R10 SERIES** <FOR TOPLIGHT COB MODULE>**4. RELIABILITY**

The reliability of products shall be satisfied with items listed below.

4-1. TEST ITEMS AND TEST CONDITIONS

NO.	TEST ITEM	TEST CONDITIONS	RESULT
1	Continuous operation test	$T_a = 25^{\circ}\text{C}$, $I_F = 180\text{ mA} \times 1000\text{ hours}$ (with Al fin)	PASS
		$T_a = 80^{\circ}\text{C}$, $T_j = 120^{\circ}\text{C}$, $I_F = 180\text{ mA} \times 1000\text{ hours}$ (with Al fin)	
2	Low temperature storage	$T_a = -40^{\circ}\text{C} \times 1000\text{ hours}$	PASS
3	High temperature storage	$T_a = 100^{\circ}\text{C} \times 1000\text{ hours}$	PASS
4	Moisture resistance	$T_a = 60^{\circ}\text{C}$, 90%RH for 1000 hours	PASS
5	Thermal shock	$T_a = -40^{\circ}\text{C} \times 30\text{ minutes} \sim 100^{\circ}\text{C} \times 30\text{ minutes}$, 100 cycle	PASS

4-2. FAILURE CRITERIA

NO.	PARAMETER	SYMBOL	FAILURE CRITERIA
1	Forward Voltage	V_F	$V_F > \text{Initial value} \times 1.1$
2	Luminous Flux	Φ	$\Phi < \text{Initial value} \times 0.7$



TECHNICAL DATA SHEET

ATE-R10 SERIES <FOR TOPLIGHT COB MODULE>

5. CHROMATICITY COORDINATES REGIONAL

5-1. 3000K CHROMATICITY COORDINATES

(Tolerance: $x,y \pm 0.005$)

($I_F = 180\text{mA}$, $T_c = 25^\circ\text{C}$)

Range		Chromaticity coordinates				
		NO.1	NO.2	NO.3	NO.4	NO.5
	x	0.4363	0.4305	0.4320	0.4340	0.4377
	y	0.4201	0.4206	0.4201	0.4188	0.4180

* The percentage of each rank in the shipment shall be determined by TOPLIGHT.

Chromaticity Diagram

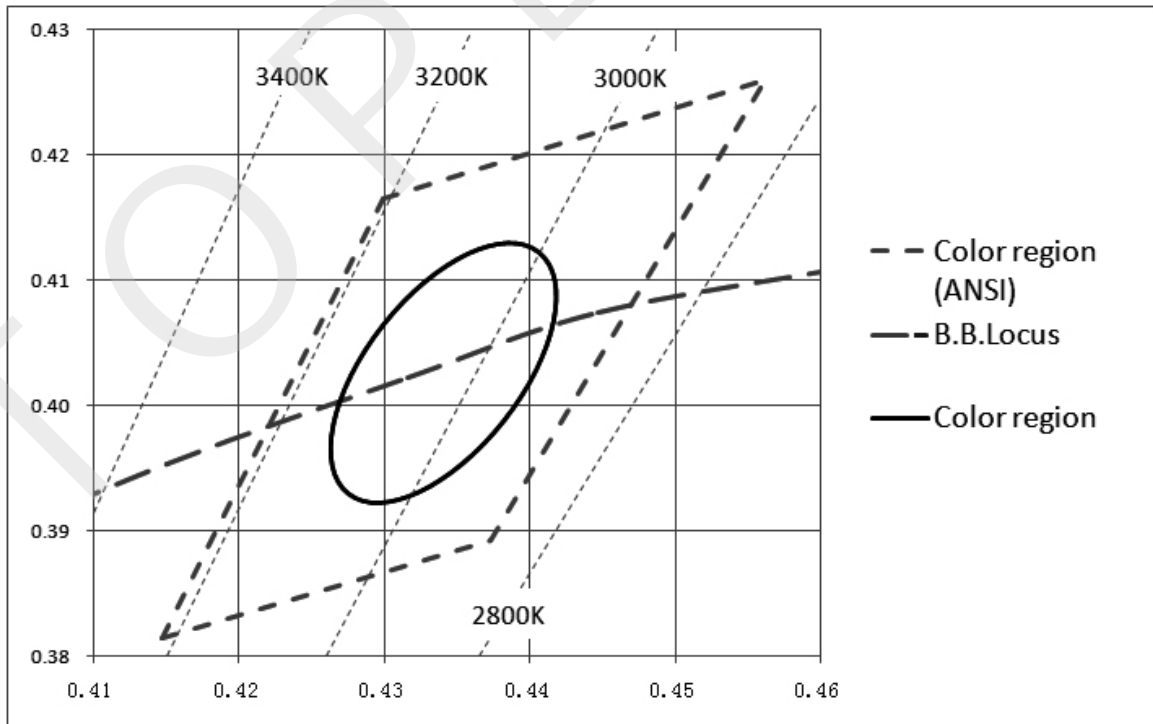

Note: The tolerance of measurement at our tester is $V_F \pm 3\%$, $D_v \pm 10\%$, Chromaticity(x,y) ± 0.005 .



TECHNICAL DATA SHEET

ATE-R10 SERIES <FOR TOPLIGHT COB MODULE>

5-2. 5000K CHROMATICITY COORDINATES

(Tolerance: $x,y \pm 0.005$)

($I_F = 180\text{mA}, T_c = 25^\circ\text{C}$)

Range		Chromaticity coordinates				
		NO.1	NO.2	NO.3	NO.4	NO.5
	x	0.3551	0.3376	0.3366	0.3515	0.3551
	y	0.376	0.3616	0.3369	0.3487	0.376

* The percentage of each rank in the shipment shall be determined by TOPLIGHT.

Chromaticity Diagram

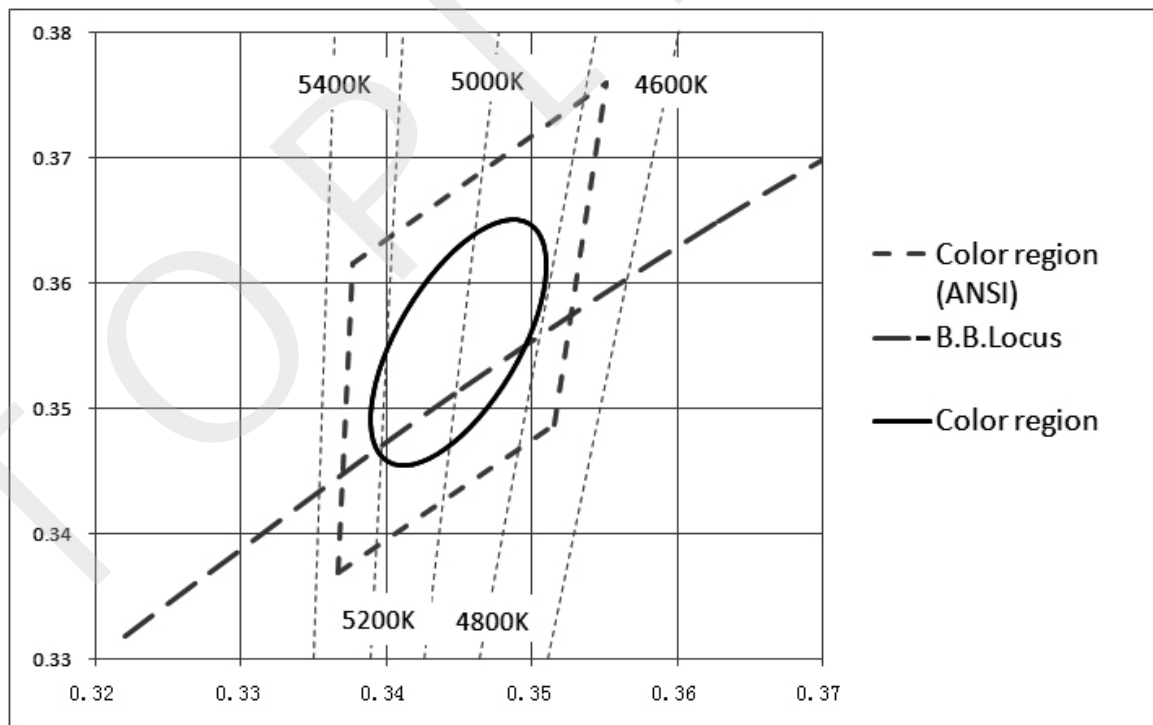

Note: The tolerance of measurement at our tester is $V_F \pm 3\%$, $D_v \pm 10\%$, Chromaticity(x,y) ± 0.005 .



TECHNICAL DATA SHEET

ATE-R10 SERIES <FOR TOPLIGHT COB MODULE>

5-3. 6500K CHROMATICITY COORDINATES

(Tolerance: $x,y \pm 0.005$)

($I_F = 180mA, T_c = 25^\circ C$)

Range		Chromaticity coordinates				
		NO.1	NO.2	NO.3	NO.4	NO.5
	x	0.3205	0.3028	0.3068	0.3221	0.3205
	y	0.3481	0.3304	0.3113	0.3261	0.3481

* The percentage of each rank in the shipment shall be determined by TOPLIGHT.

Chromaticity Diagram

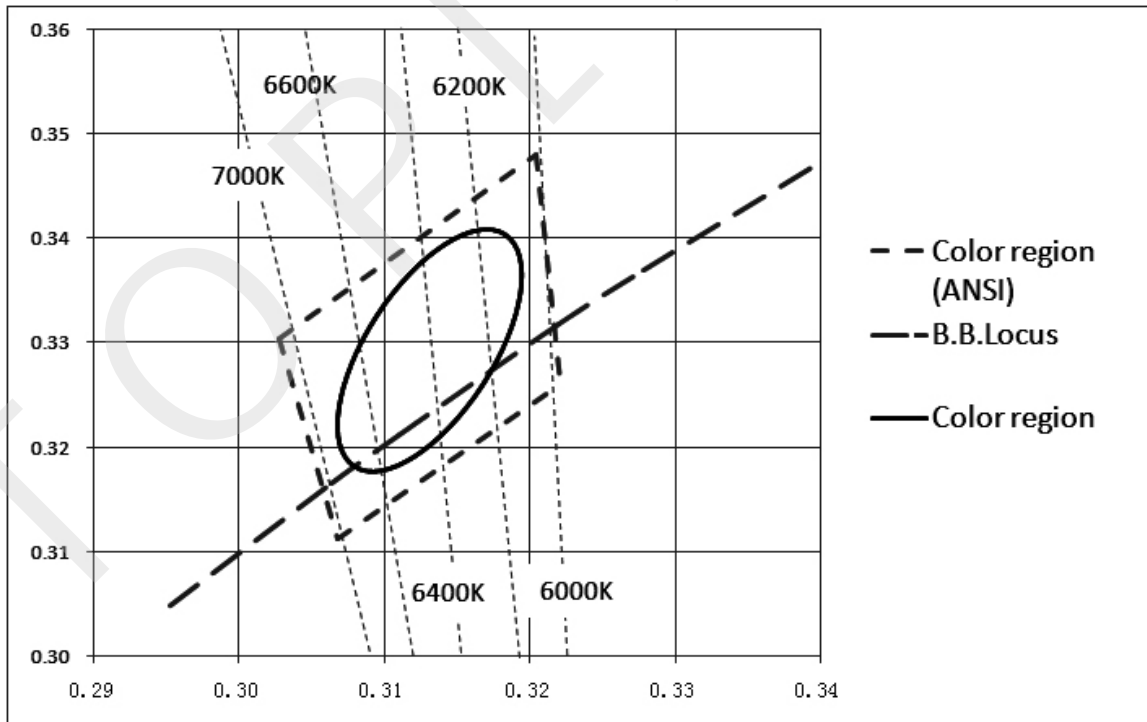

Note: The tolerance of measurement at our tester is $V_F \pm 3\%$, $D_v \pm 10\%$, Chromaticity(x,y) ± 0.005 .